

# UN 1H2 OPEN-HEAD PAIL CLOSING INSTRUCTIONS

## STATEMENT OF NOTIFICATION REQUIREMENTS

The instructions contained herein apply to U.N. Rated Openhead Pails and Covers Marketed under the BWAY, NAMPAAC, and ICI brand names. These instructions are provided to the filler of BWAY's UN certified packaging in accordance with §178.2(c) of the U.S. Department of Transportation's (DOT) hazardous materials regulations, Title 49 of the Code of Federal Regulations (CFR). The instructions apply exclusively to 1H2 single unit packaging of the type and style as described herein and bearing a UN certification marking. At the time of transfer, any package or packaging component supplied by BWAY does not meet the UN standard because it is disassembled. Only when assembled in the manner, and using the components described herein, is this packaging certified by BWAY to meet the UN standard.

It is the regulatory obligation of the packaging filler to properly assemble and close UN certified packaging. If the packaging is not assembled and closed per these instructions, or if any of the components are omitted or replaced with substitute components, this packaging is not certified by BWAY as meeting the UN performance standard. It is the regulatory obligation of the shipper to determine that the filled package is authorized for transportation. When transporting by air, the general requirements for transportation by aircraft in §173.27 of Title 49 CFR must also be met.

## APPLICABLE BWAY UN 1H2 COMPONENTS

**1H2 CONTAINER:**

- UN Rated (NA-Series) Open Head Pail (3.5 – 7.0 UN Gal)

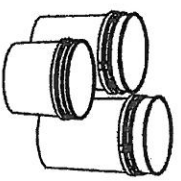

**COVERS:**

- UN 0234 Series Cover with Tubular Rubber Gasket (Approved for Liquids & Solids)



- UN 6500 Series Tear Skirt Cover with Tubular Rubber Gasket (Approved for Solids Only)



- UN Tri-Seal Cover, Gasketless (Approved for Solids Only)



**CLOSURES: (See BWAY's Variation 5 Certifications for approved closure listing)**

- 70mm Screw Caps with Gasket

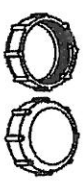

- Crimp-on Pour Spouts (Vented and unvented)



**VENTS: (See BWAY's Variation 5 Certifications for approved closure listing)**

- Pierce Membrane Vent (Liquids)

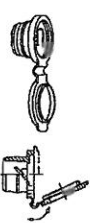

## BWAY UN OPEN-HEAD SNAP-ON COVER APPLICATION REQUIREMENTS

BWAY's openhead pails and covers are designed to be assembled by pressing the cover downward onto the top of the pail with a sufficient amount of force that the internal lip of the cover stretches over the outer lip of the pail and snaps back into place beneath it. There are many types of closing machines and tools available for accomplish this task. Most of these devices do an excellent job of closing a commercial-duty BWAY container. However, due to the rigorous test requirements established by the United Nations and adopted by the DOT, UN packaging must be closed properly in order to meet performance requirements, which are absolutely essential to the safe containment and transport of materials. Therefore, BWAY only endorses the following cover installation methods, listed here in order of preference.

### VERTICAL CYLINDER PRESS

For optimum UN package performance, BWAY strongly endorses the use of a vertical cylinder press. This style of capping press uses a vertically-mounted cylinder, generally pneumatic, to apply a uniform pressure across the cover-pail interface and ensures consistent cover installation without deforming the cover or the sealing gasket beyond design limitations.

The amount of force necessary to properly apply a BWAY UN cover is considerably more than required to apply a typical commercial-grade cover. Minimally, a 5" diameter pneumatic cylinder using 115 to 130 psi air pressure is required to properly apply a BWAY UN cover. If a larger cylinder is used, the air pressure can be lowered accordingly. BWAY recommends a vertical cylinder press having a piston diameter of 6" and 80 to 90 psi air pressure. When capping, the application pressure must be maintained for a minimum of 1 - 2 seconds and the cylinder must be allowed to stroke a minimum of 1/4" below the top of covers to ensure proper installation.

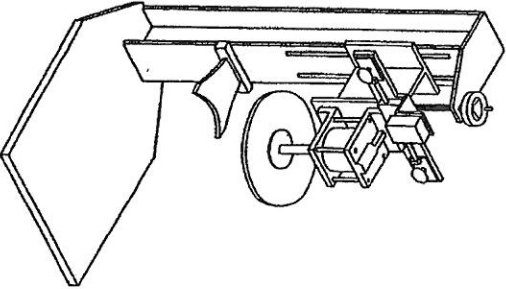

The cover press closing plate (platen) must be parallel to the base within 0.05" and must have sufficient strength to minimize deflection during application of the cover. The use of a Burr Plug (a plug protruding from the center of the capper platen designed to bow the cover slightly during capping to allow excess air to escape) is not recommended when applying BWAY's UN cover.

### ROLL-ON PRESS

The roll-on cover press, also known as a roller capper or roller closer, is a high-speed closing unit typically used in high volume filling operations. It is generally used in conjunction with a thru-feed conveyor which passes the pail and cover under the capping rollers. These rollers exert a down force onto the cover as it passes, forcing the internal lip of the cover to stretch over the outer lip of the pail and snap back into place beneath it.

It is critical to keep the roll-on cover press adjusted to the open-head container height variances to ensure that the package is not stressed during cover application. BWAY suggests that, as a starting point for capping UN rated openhead packages, the exit end of a roll-on cover press be set to the pail height (without cover) plus 0.200". Minor adjustments from this initial height setting may be necessary to ensure complete cover installation. Always verify that the capper is installing the cover properly and completely before going into production.

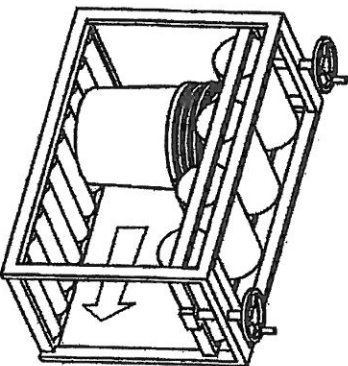

Design and operating rates for this type of press vary greatly. For this reason, BWAY cannot unilaterally endorse this style of capping press for use with 1H2 UN openhead packaging. The package filler must evaluate their individual roll-on press to verify that the press is capable of consistently seating the cover completely onto the openhead pail.

### MALLET / HAMER

This is the least expensive and generally very effective method for the installation of a typical commercial-grade pail cover. However, using a mallet to generate the force that must be applied to various parts of the BWAY UN cover in order to fully seat it onto the pail can damage the cover and/or the gasket during installation. Only rubber-faced mallets may be used to close BWAY's UN-rated openhead package.

Due to the hazardous nature of the products packaged in UN containers, mallet capping BWAY's UN certified containers is not the preferred capping method. Packers are encouraged to use equipment that applies a uniform and consistent capping pressure.

## GENERAL COVER INSTALLATION INSTRUCTIONS

- Before seating a UN rated cover onto a UN rated openhead pail, visually inspect the mating surfaces of each component. For pails, verify that the pail lip is free of defects and debris. For gasketed covers, ensure that the tubular gasket is fully seated inside the cover, is not twisted or deformed, and that there are no plastic hairs or debris on its visible surfaces. For Tri-Seal gasketless covers, ensure that the visible sealing areas inside the cover are clean and defect free.
  - After filling the pail to the appropriate volume, loosely place the inspected cover on top of it and verify that the cover is aligned with the pail and resting reasonably flat.
  - Apply the cover using the appropriate capping apparatus.
    - For vertical cylinder presses, engage the pressure cylinder and apply a downward capping force for 1-2 sec's or until all audible capping sounds have ceased, then release.
    - For roll-on presses, feed the pail with cover through the press until it exits the discharge end.
  - Inspect the closed package to verify that the cover is fully seated onto the pail. Localized bulging of the cover sidewall is an indication that the cover has not fully latched. Adjust the down force of the capper as needed and re-cap the package until the cover is fully seated.
- Caution:** The application force required to install the UN cover fully onto the UN pail will vary according to ambient temperature and the closing speed of the cover press. Adjustments of speed and pressure may be necessary to optimize cover installation. Always verify capper settings before proceeding with production.

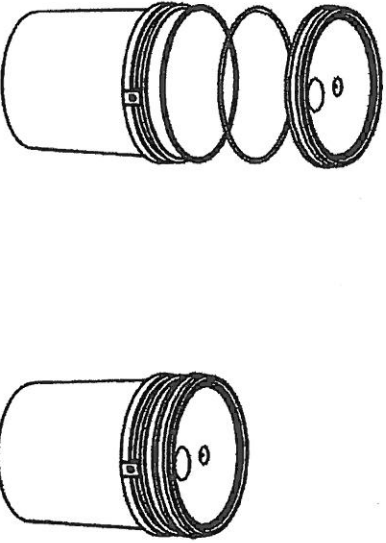

## CLOSURE AND FITMENT INSTRUCTIONS

In addition to plain panel covers, which have no additional fitments or closures, BWAY's UN covers are also available in liquid-rated versions with threaded and crimp-on neck finishes as well vented versions for both liquids and solids. BWAY may pre-install fittings into or onto these openings for the convenience of the package filler or supply them separately. In either case, it is the package filler's responsibility to ensure that the fitment or closure is completely installed and/or properly torqued, crimped, or pressed into position before the filled package is shipped.

### THREADED FITMENTS (Screw cap installation)

#### APPARATUS:

- > 70mm Torque Head Fixture
- > Torque Wrench (break-away or digital read-out style preferred)

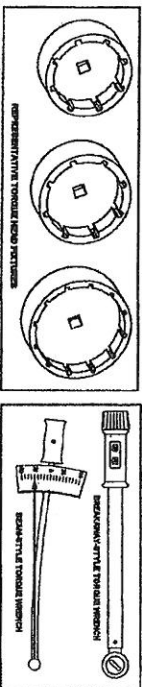

#### PROCEDURE:

- Inspect the top surface of the neck to ensure an acceptable sealing surface, clean and free of any debris.
- Inspect the cap to ensure the gasket is properly assembled and is clean.
- Start the cap on the neck by hand, rotating the cap in a clock-wise direction. Take care not to cross thread the cap; this will result in damage to the cap or to the neck finish.
- Using the 70mm torque head fixture mounted onto a torque wrench, tighten the cap per the table below.

CAP SIZE (DIA)	Thread Pitch	INSTALLATION TORQUE
70mm	8TPI (3mm)	120 IN.-LBS (10 FT.-LBS)
70mm	6TPI (4mm)	180 IN.-LBS (15 FT.-LBS)

### 63mm CRIMP-ON FITMENTS (Pour Spout Installation)

BWAY generally provides crimp-on fittings pre-installed onto openhead pail covers. In such cases, the package filler need only visually verify that the crimp-on fitting has been installed and fully crimped. If the package filler is to install the crimp-on fitting, then the following procedure must be used. The proper seating (assembly) of the crimp-on fitting to the BWAY container is absolutely essential to the safe containment and transport of hazardous materials.

**Note:** Always inspect the sealing surfaces of both mating components to ensure that they are clean and free of debris prior to assembly.

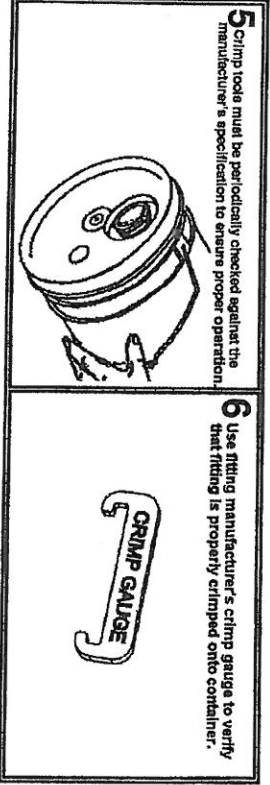
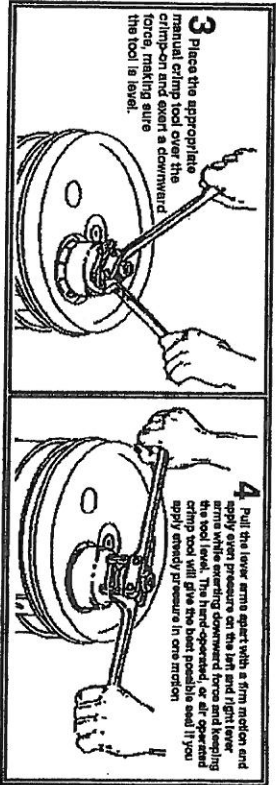
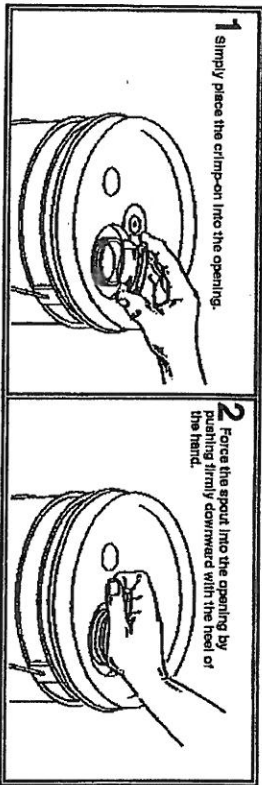

### VENT OPTIONS AND INSTALLATION

BWAY's UN covers are available in two vented versions, an umbrella-style Buna vent for solids applications which permits vapors from the contents to vent to atmosphere and a pierce-membrane vent with hinged overcap for liquid applications which prevents gugging during pour-out. Vents are typically pre-installed by BWAY, but it is ultimately the package filler's responsibility to ensure that the vents are present and installed properly before the filled package is shipped.

#### Umbrella-Style Buna Vent

1. View the vent insert from both the inside and outside of the cover and verify that the insert is fully seated against the outer cover face and the retention features of the insert have snapped through and protrude from the inner cover face.
2. If the retention features cannot be seen protruding from the inside face of the cover, apply pressure to the top surface of the insert until it snaps into position.

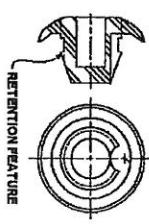

#### Pierce-Membrane Vent

1. View the vent insert from both the inside and outside of the cover and verify that the insert is fully seated against the outer cover face and the retention features of the insert have snapped through and protrude from the inner cover face.
2. If the retention features cannot be seen protruding from the inside face of the cover, apply pressure to the top surface of the insert until it snaps into position.
3. Open the hinged over cap and visually verify that the membrane is intact and unbroken. This insert is only certified for shipment with the membrane intact. Once the membrane is broken, the cover can only be used for local storage.

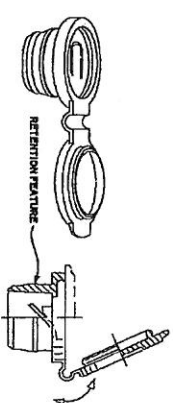



**CLOSURES WITH PREE MEMBRANE VENTS**

BWAY certifies several vented closures for use with UN rated openhead pails and covers. These closures typically utilize an expanded PTFE (breathable) membrane that permits gases to escape while retaining the liquid contents of the container, preventing dangerous container pressurization. This vent membrane will only function properly if it is in good condition and is openly exposed to the vacant headspace inside the container.

1. Visually inspect the membrane on the underside of the closure before installation to ensure that it is securely attached to the closure and free of defects or foreign materials.
2. Secure the closure to the container as directed elsewhere in this document.
3. Never overfill the container to the point where fluid contacts the closure membrane. The membrane *must* be exposed to the open headspace so that the container can breathe properly.

**CLOSING, CRIMPING AND CAPPING TOOL & EQUIPMENT SUPPLIERS**

The following is a list of suppliers and manufacturers of various pail capping tools and equipment. This list is by no means complete and BWAY does not specifically endorse any of the companies listed. The list is offered purely as a courtesy to our valued customers.

**Lid Closers (vertical cylinder press and/or roll-on closers)**

Heiser Manufacturing  
Atlanta Grotnes Machine Co.  
Crandall International, Inc.  
Palmdate

**Crimpers for 63mm Fittings**

Rieke Corporation  
Tri-Sure Worldwide  
APC Products Limited

**Screw cap Wrench Heads (for Screw cap Torquing)**

The Cary Company  
Rieke Corporation

**Distributors of Fittings and Tooling**

The Cary Company

**CLOSURE TOOL REFERENCE TABLE**

Closure Mfg'r	Closure Types	Closure Size (mm)	Closure Tool Model	Closure Tool Description
American Flange	Tri-Sure Tab Seal	70	UG	Manual Chimping Tool
	Tri-Sure Uni-Grip		UAG	Pneumatic Chimping Tool
Norpak / Norton	Norcap	70		Seekonk Torque Wrench (Gauge) or Equivalent with Rieke Cap Wrench Adapter, W394; or contact your Norpak/Norton representative for equivalent adapter
	Norcap Vented			Seekonk Torque Wrench (Gauge) or Equivalent with Rieke Cap Wrench Adapter, W394; or contact your Republic representative for equivalent adapter
Republic	Comack	70		Seekonk Torque Wrench (Gauge) or Equivalent with Rieke Cap Wrench Adapter, W394
	Comack			
	TEXT			
	SC63R			
	Vented			
	Vented			
Rieke	FS-60	70		Seekonk Torque Wrench (Gauge) or Equivalent with Rieke Cap Wrench Adapter, W394
	FS-70			
	FS-70			
	Vented			
	FS-80			
	FS-80 Vented			
Rieke	FS-80-T	70		Manual Flexpout Chimping Tool
	FS-10-6-300		FS-600	Manual Flexpout Chimping Tool
	FS-10-6-624		IA-FS-600	Airmatic Flexpout Chimping Tool
	FS-10-8V-300		HFS-600	Airdraulic Flexpout Chimping Head and Hose
	FS-II			